



Is Now Part of



ON Semiconductor®

To learn more about ON Semiconductor, please visit our website at
www.onsemi.com

ON Semiconductor and the ON Semiconductor logo are trademarks of Semiconductor Components Industries, LLC dba ON Semiconductor or its subsidiaries in the United States and/or other countries. ON Semiconductor owns the rights to a number of patents, trademarks, copyrights, trade secrets, and other intellectual property. A listing of ON Semiconductor's product/patent coverage may be accessed at www.onsemi.com/site/pdf/Patent-Marking.pdf. ON Semiconductor reserves the right to make changes without further notice to any products herein. ON Semiconductor makes no warranty, representation or guarantee regarding the suitability of its products for any particular purpose, nor does ON Semiconductor assume any liability arising out of the application or use of any product or circuit, and specifically disclaims any and all liability, including without limitation special, consequential or incidental damages. Buyer is responsible for its products and applications using ON Semiconductor products, including compliance with all laws, regulations and safety requirements or standards, regardless of any support or applications information provided by ON Semiconductor. "Typical" parameters which may be provided in ON Semiconductor data sheets and/or specifications can and do vary in different applications and actual performance may vary over time. All operating parameters, including "Typicals" must be validated for each customer application by customer's technical experts. ON Semiconductor does not convey any license under its patent rights nor the rights of others. ON Semiconductor products are not designed, intended, or authorized for use as a critical component in life support systems or any FDA Class 3 medical devices or medical devices with a same or similar classification in a foreign jurisdiction or any devices intended for implantation in the human body. Should Buyer purchase or use ON Semiconductor products for any such unintended or unauthorized application, Buyer shall indemnify and hold ON Semiconductor and its officers, employees, subsidiaries, affiliates, and distributors harmless against all claims, costs, damages, and expenses, and reasonable attorney fees arising out of, directly or indirectly, any claim of personal injury or death associated with such unintended or unauthorized use, even if such claim alleges that ON Semiconductor was negligent regarding the design or manufacture of the part. ON Semiconductor is an Equal Opportunity/Affirmative Action Employer. This literature is subject to all applicable copyright laws and is not for resale in any manner.



ON Semiconductor®

October 2016

FAN7191_F085 High-Current, High and Low Side Gate Drive IC

Features

- Floating Channel for Bootstrap Operation to +600V
- 4.5A Sourcing and 4.5A Sinking Current Driving Capability
- Common-Mode dV/dt Noise Cancelling Circuit
- Built-in Under-Voltage Lockout for Both Channels
- Matched Propagation Delay for Both Channels
- 3.3V and 5V Input Logic Compatible
- Output In-phase with Input
- Qualified to AEC Q100

Applications

- Advanced Fuel Injection Systems
- Automotive high voltage DC-DC converters
- Starter/Alternator
- Electric Power Steering
- Motor Control (fans, pumps, compressors)
- MOSFET and IGBT driver applications

Description

The FAN7191_F085 is a monolithic high- and low-side gate-drive IC, which can drive high speed MOSFETs and IGBTs that operate up to +600V. It has a buffered output stage with all NMOS transistors designed for high pulse driving capability and minimum cross-conduction.

Fairchild's high-voltage process and common-mode noise canceling technique provide stable operation of high-drivers under high dV/dt noise circumstances. An advanced level-shift circuit allows high-side gate driver operation up to $V_s = -9.8V$ (typical) for $V_{BS} = 15V$.

The UVLO circuit prevents malfunction when V_{DD} and V_{BS} are lower than the specified threshold voltage.

The high current and low output voltage drop features make this device suitable for controlling direct injection actuators and for use in many automotive DC-DC converter and motor control applications.

8-SOP



Figure 1. Package Options

Ordering Information

Part Number	Operating Temperature Range	Package	 Eco Status	Packing Method
FAN7191MX_F085	-40°C to +125°C	8-SOP	RoHS	Tape & Reel

 For Fairchild's definition of "green" Eco Status, please visit: http://www.fairchildsemi.com/company/green/rohs_green.html.

FAN7191_F085 – High-Current, High and Low Side Gate Drive IC

Typical Application Circuit

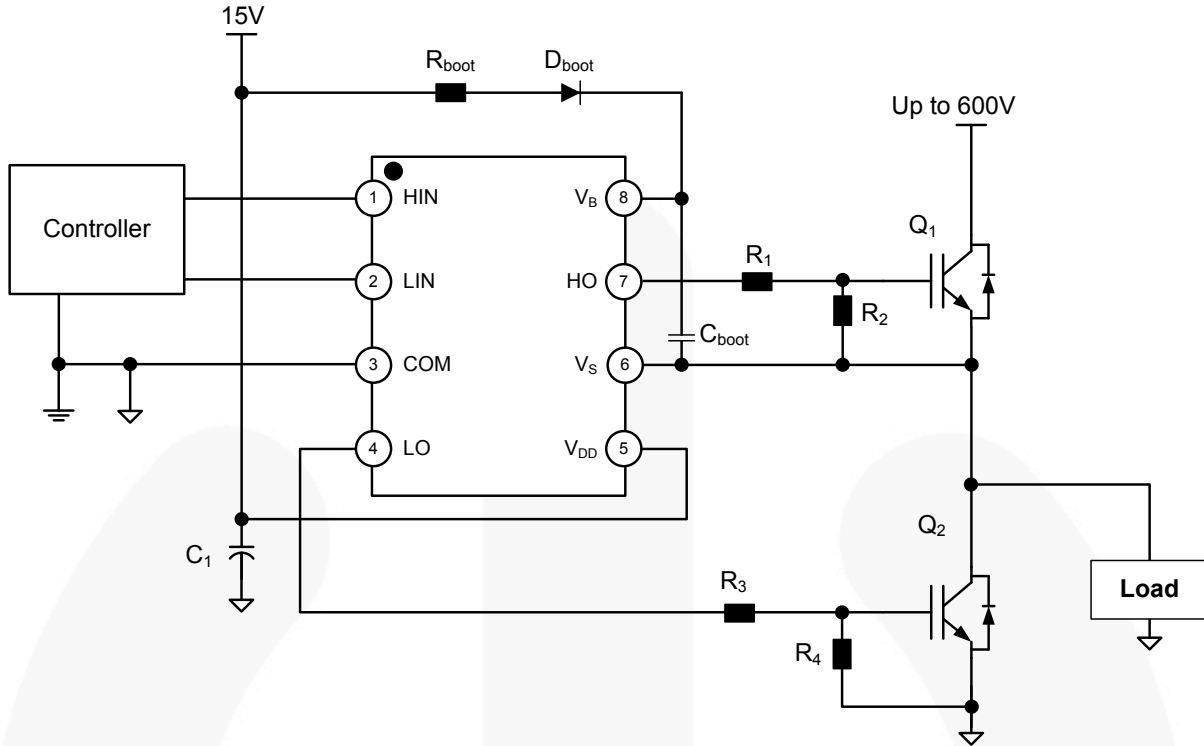

Figure 2. Half-Bridge Application Circuit (8-SOP)

Internal Block Diagram

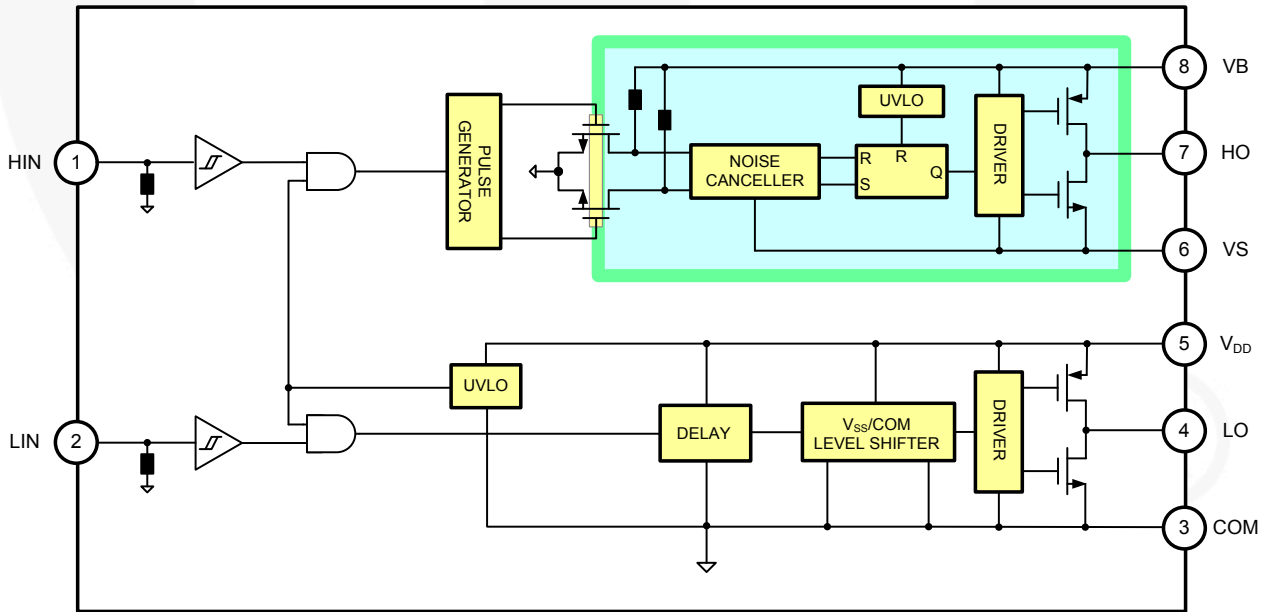

Figure 3. Functional Block Diagram (8-SOP)

Pin Assignment

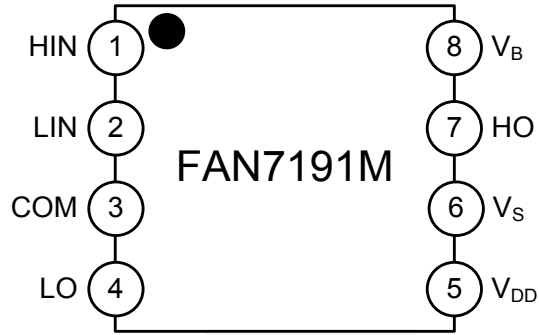

Figure 4. Pin Assignments (Top View)

Pin Definitions

8-Pin	Name	Description
1	HIN	Logic Input for High-Side Gate Driver Output
2	LIN	Logic Input for Low-Side Gate Driver Output
3	COM	Low-side Driver Return
4	LO	Low-Side Driver Output
5	V_{DD}	Low-Side and Logic Power Supply Voltage
6	V_S	High-Side Floating Supply Return
7	HO	High-Side Driver Output
8	V_B	High-Side Floating Supply

Absolute Maximum Ratings

Stresses exceeding the absolute maximum ratings may damage the device. The device may not function or be operable above the recommended operating conditions and stressing the parts to these levels is not recommended. In addition, extended exposure to stresses above the recommended operating conditions may affect device reliability. The absolute maximum ratings are stress ratings only.

TA = 25°C, unless otherwise specified. VB, VDD and VIN are referenced to COM for FAN7191M (8-SOP).

Symbol	Parameter		Min.	Max.	Unit
VS	High-side offset voltage VS		VB-25	VB+0.3	V
VB	High-side floating supply voltage VB		-0.3	625	V
VHO	High-side floating output voltage		VS-0.3	VB+0.3	V
VDD	Low-side and logic-fixed supply voltage		-0.3	25	V
VIN	Logic Input voltage (HIN, LIN, EN)		-0.3	VDD+0.3	V
VLO	Low-Side Output Voltage LO		COM-0.3	VDD+0.3	V
t _{pulse}	Minimum Pulse Width ⁽⁴⁾		80		ns
d _{VS/dt}	Allowable offset voltage slew rate			50	V/ns
PD ⁽¹⁾⁽²⁾⁽³⁾	Power dissipation		8-SOP	0.625	W
	Thermal Resistance, junction-to-ambient		8-SOP	200	°C/W
θ _{JA}	Thermal Resistance, junction-to-ambient		8-SOP	200	°C/W
T _J	Junction temperature			+150	°C
T _S	Storage temperature		-55	+150	°C
ESD	Electrostatic Discharge Capability	Human Body Model, ANSI/ESDA/JEDEC JS-001-2012		3000	V
		Charged Device Model, JESD22-C101		2000	

Notes:

1. Mounted on 76.2 x 114.3 x 1.6mm PCB (FR-4 glass epoxy material).
2. Refer to the following standards:
 JESD51-2: Integral circuits thermal test method environmental conditions – natural convection
 JESD51-3: Low effective thermal conductivity test board for leaded surface mount packages
3. Do not exceed PD under any circumstances.
4. Minimum input pulse which is guaranteed to produce an output pulse.

Recommended Operating Conditions

The Recommended Operating Conditions table defines the conditions for actual device operation. Recommended operating conditions are specified to ensure optimal performance to the datasheet specifications. Fairchild does not recommend exceeding them or designing to Absolute Maximum Ratings. VDD is referenced to COM for FAN7191M (8-SOP).

Symbol	Parameter	Min.	Max.	Unit
VB	High-side floating supply voltage	VS+10	VS+22	V
VS	High-side Floating Supply Offset Voltage	6-VDD	600	V
VHO	High-side Output Voltage	VS	VB	V
VDD	Low-side and Logic Supply voltage	10	22	V
VLO	Low-side output voltage	COM	VDD	V
VIN	Logic input voltage (HIN, LIN)	COM	VDD	V
COM	Power Ground	VSS-0.5	VSS+0.5	V
TA	Ambient Temperature	-40	+125	°C

Electrical Characteristics

V_{BIAS} (V_{DD} , V_{BS}) = 15.0V, V_S = COM, T_A = 25°C, unless otherwise specified. The V_{IL} , V_{IH} and I_{IN} parameters are referenced to COM and are applicable to the respective input signals HIN and LIN. The V_O and I_O parameters are referenced to COM. V_S and GND and are applicable to the respective outputs HO and LO.

Symbol	Characteristic	Condition	Min.	Typ.	Max.	Unit
POWER SUPPLY SECTION (V_{DD} and V_{BS})						
V_{DDUV+} V_{BSUV+}	V_{DD} and V_{BS} Supply Under-Voltage Positive-going Threshold		7.8	8.8	9.8	V
V_{DDUV-} V_{BSUV-}	V_{DD} and V_{BS} Supply Under-Voltage Negative Going Threshold		7.2	8.3	9.1	
V_{DDHYS}	V_{DD} supply under-voltage lockout hysteresis			0.5		
I_{LK}	Offset Supply Leakage Current	$V_B = V_S = 600V$			50	μA
I_{QBS}	Quiescent V_{BS} Supply Current	$V_{IN} = 0V$ or 5V		45	110	
I_{QDD}	Quiescent V_{DD} Supply Current	$V_{IN} = 0V$ or 5V		75	150	
I_{PBS}	Operating V_{BS} Supply Current	$f_{IN} = 20kHz$, rms value		400	800	μA
I_{PDD}	Operating V_{DD} Supply Current	$f_{IN} = 20kHz$, rms value		400	800	
LOGIC INPUT SECTION (HIN, LIN, EN)						
V_{IH}	Logic "1" Input Voltage		2.5			V
V_{IL}	Logic "0" Input Voltage				1.2	
I_{IN+}	Logic "1" Input Bias Current (HIN/LIN)	$V_{IN} = 5V$		25	50	μA
I_{IN-}	Logic "0" Input Bias Current (HIN/LIN)	$V_{IN} = 0V$		1.0	2.0	
R_{IN}	Input Pull-down Resistance		100	200		k Ω
GATE DRIVER OUTPUT SECTION (HO, LO)						
V_{OH}	High-level Output Voltage, $V_{BIAS}-V_O$	No Load			1.35	V
V_{OL}	Low-level Output Voltage, V_O	No Load			35	mV
I_{O+}	Output HIGH, Short-circuit Pulsed Current	$V_O=0V$, $V_{IN}=5V$ with $PW<10\mu s$	3.5	4.5		A
I_{O-}	Output LOW Short-circuit Pulsed Current	$V_O=15V$, $V_{IN}=0V$ with $PW<10\mu s$	3.5	4.5		
V_S	Allowable Negative V_S Pin Voltage for HIN Signal Propagation to HO			-9.8	-7.0	V

Note:

5. This parameter guaranteed by design.

Dynamic Electrical Characteristics

V_{BIAS} (V_{DD} , V_{BS}) = 15.0V, V_S = COM = 0V, T_A = 25°C, $C_{LOAD}=1000pF$ unless otherwise specified.

Symbol	Characteristic	Condition	Min.	Typ.	Max.	Unit
t_{on}	Turn-on Propagation Delay	$V_S=0V$		140	200	ns
t_{off}	Turn-off Propagation Delay	$V_S=0V$		140	200	ns
MT	Delay Matching				55	ns
t_r	Turn-off Rise Time			25	50	ns
t_f	Turn-off Fall Time			25	50	ns

Typical Characteristics

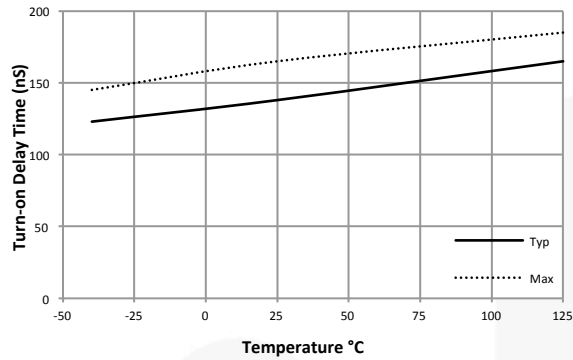

Figure 7. Turn-on Propagation Delay vs. Temperature

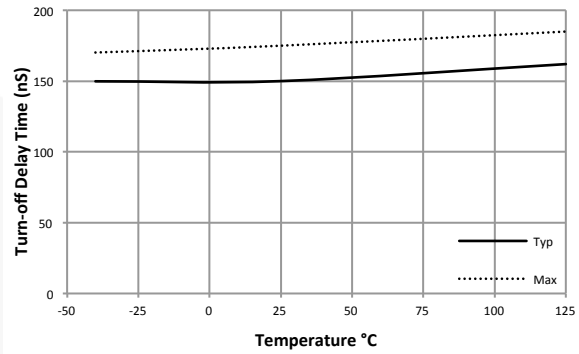

Figure 8. Turn-off Propagation Delay vs. Temperature

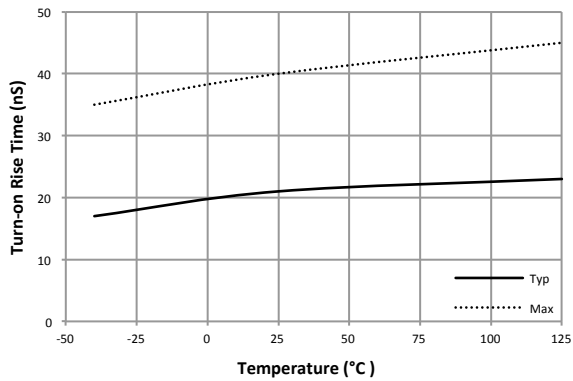

Figure 9. Turn-on Rise Time vs. Temperature

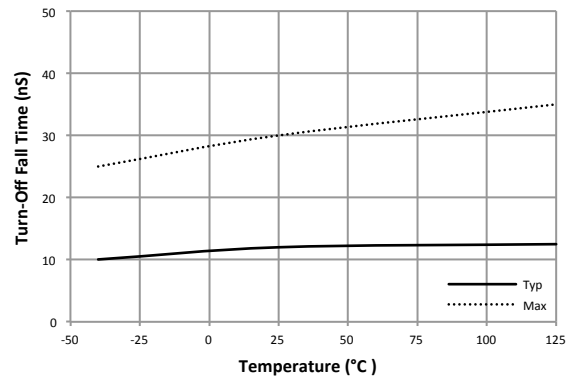

Figure 10. Turn-off Fall Time vs. Temperature

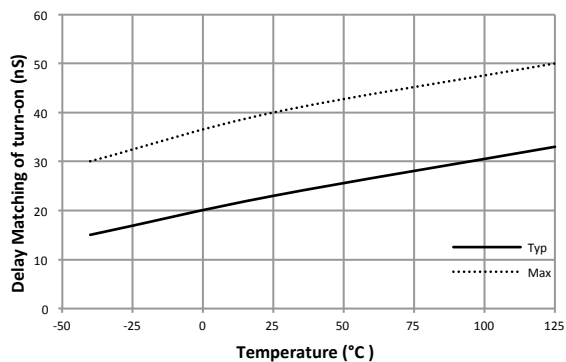

Figure 11. Turn-on Delay Matching vs. Temperature

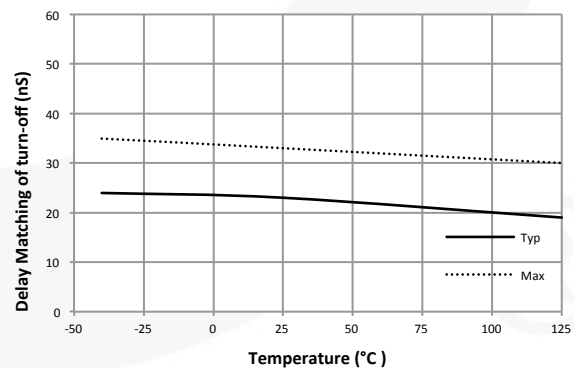

Figure 12. Turn-off Delay Matching vs. Temperature

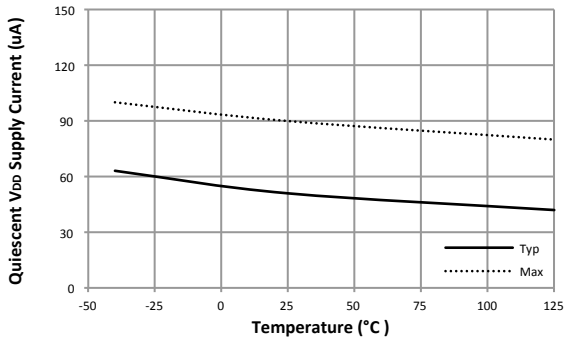

Figure 13. Quiescent V_{DD} Supply Current vs. Temperature

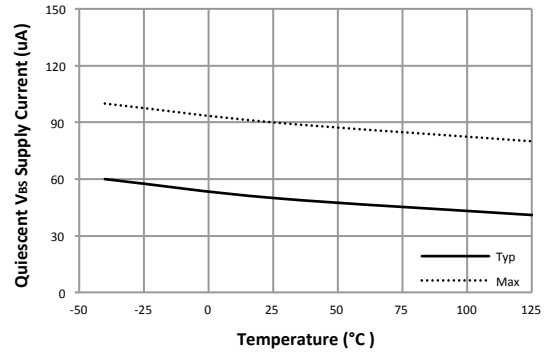

Figure 14. Quiescent V_{BS} Supply Current vs. Temperature

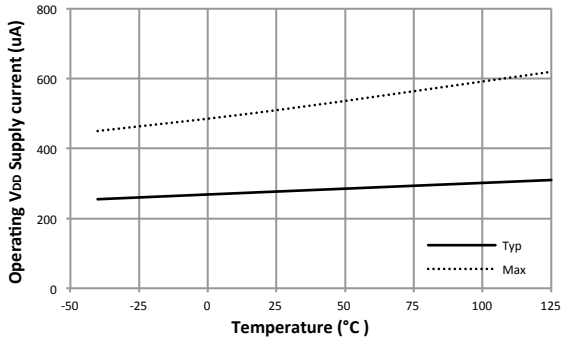

Figure 15. Operating V_{DD} Supply Current vs. Temperature

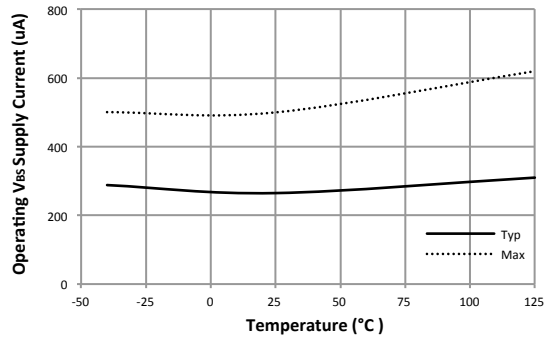

Figure 16. Operating V_{BS} Supply Current vs. Temperature

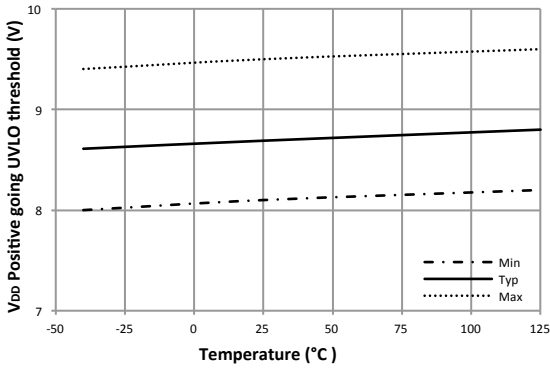

Figure 17. V_{DD} UVLO+ vs. Temperature

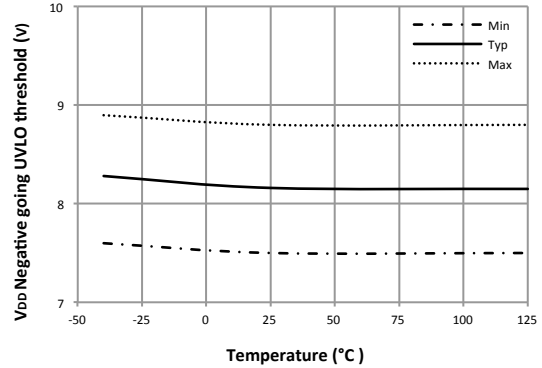

Figure 18. V_{DD} UVLO- vs. Temperature

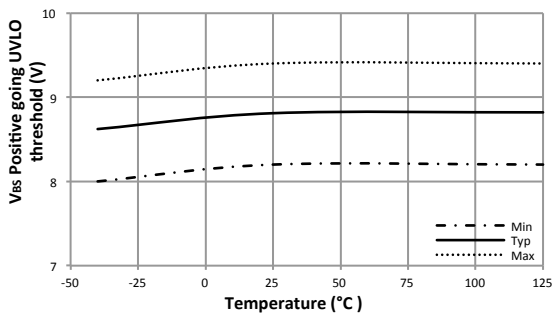

Figure 19. V_{BS} UVLO+ vs. Temperature

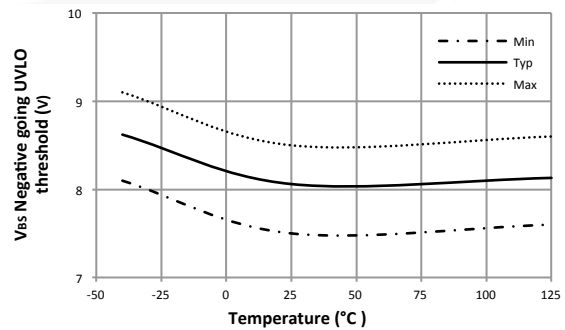

Figure 20. V_{BS} UVLO- vs. Temperature

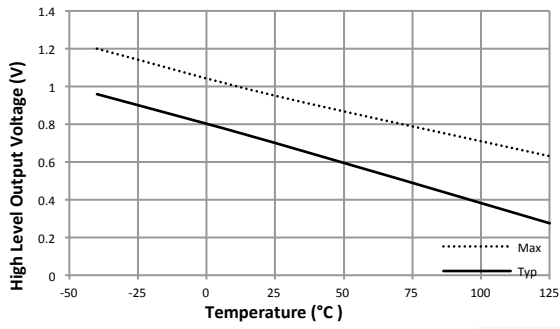

Figure 21. High-Level Output Voltage vs. Temperature

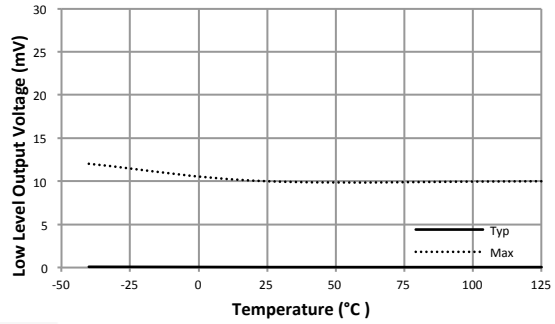

Figure 22. Low-Level Output Voltage vs. Temperature

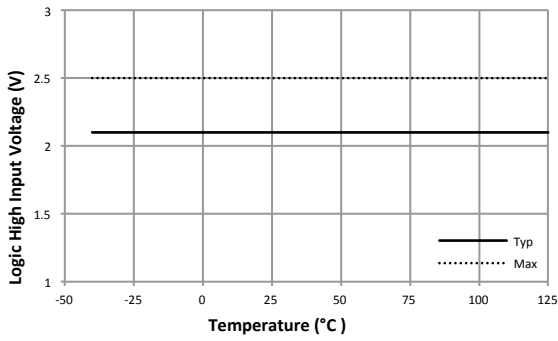

Figure 23. Logic High Input Voltage vs. Temperature

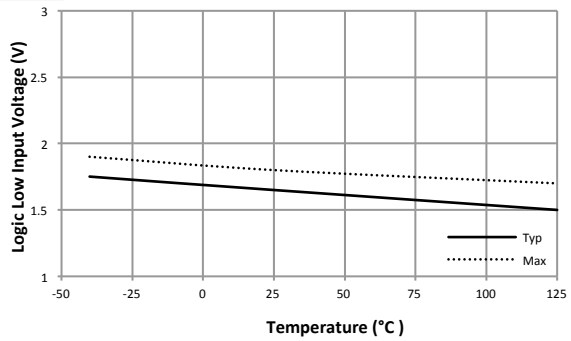

Figure 24. Logic Low Input Voltage vs. Temperature

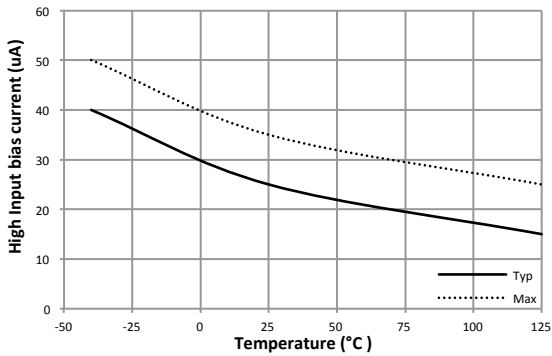

Figure 25. Logic "1" Input Bias Current vs. Temperature

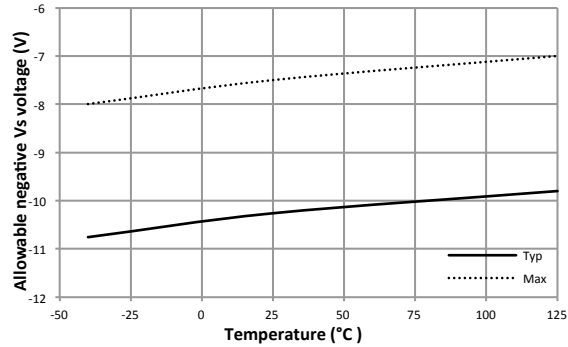

Figure 26. Allowable Negative V_S Voltage vs. Temperature

Switching Time Definitions

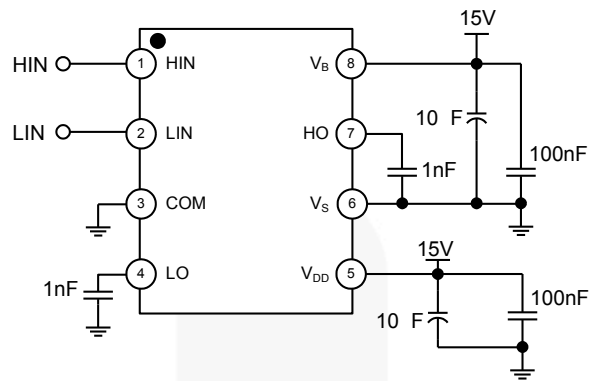

Figure 27. Switching Time Test Circuit (8-SOP)

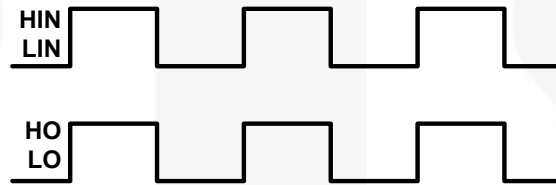

Figure 28. Input/Output Timing Diagram

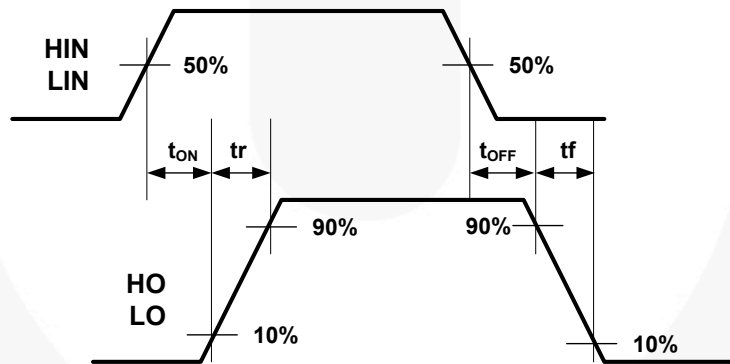

Figure 29. Switching Time Waveform Definitions

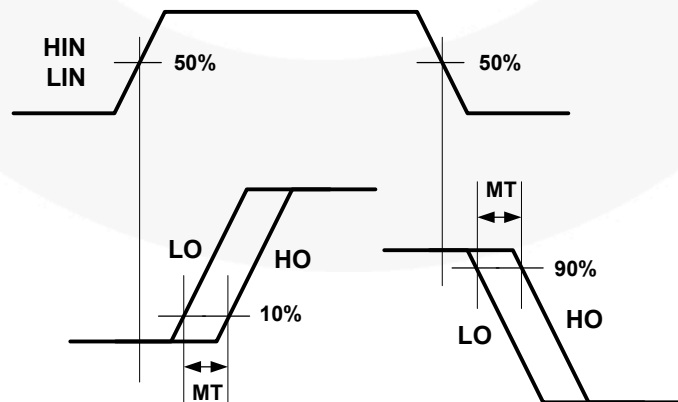

Figure 30. Delay Matching Waveform Definition

Package Dimensions

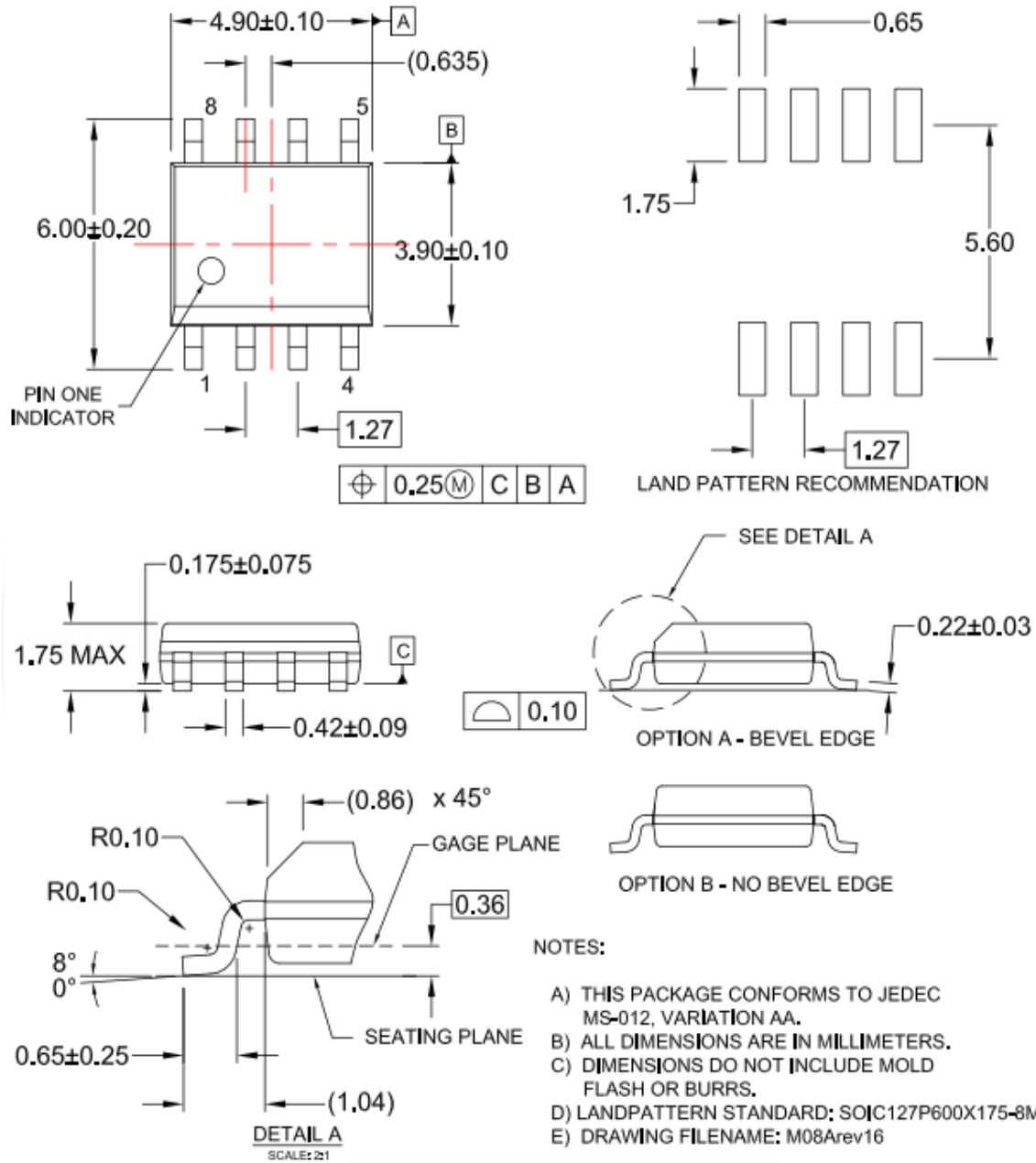



Figure 31. 8-Lead, Small Outline Package (SOP)



ON Semiconductor and  are trademarks of Semiconductor Components Industries, LLC dba ON Semiconductor or its subsidiaries in the United States and/or other countries. ON Semiconductor owns the rights to a number of patents, trademarks, copyrights, trade secrets, and other intellectual property. A listing of ON Semiconductor's product/patent coverage may be accessed at www.onsemi.com/site/pdf/Patent-Marking.pdf. ON Semiconductor reserves the right to make changes without further notice to any products herein. ON Semiconductor makes no warranty, representation or guarantee regarding the suitability of its products for any particular purpose, nor does ON Semiconductor assume any liability arising out of the application or use of any product or circuit, and specifically disclaims any and all liability, including without limitation special, consequential or incidental damages. Buyer is responsible for its products and applications using ON Semiconductor products, including compliance with all laws, regulations and safety requirements or standards, regardless of any support or applications information provided by ON Semiconductor. "Typical" parameters which may be provided in ON Semiconductor data sheets and/or specifications can and do vary in different applications and actual performance may vary over time. All operating parameters, including "Typicals" must be validated for each customer application by customer's technical experts. ON Semiconductor does not convey any license under its patent rights nor the rights of others. ON Semiconductor products are not designed, intended, or authorized for use as a critical component in life support systems or any FDA Class 3 medical devices or medical devices with a same or similar classification in a foreign jurisdiction or any devices intended for implantation in the human body. Should Buyer purchase or use ON Semiconductor products for any such unintended or unauthorized application, Buyer shall indemnify and hold ON Semiconductor and its officers, employees, subsidiaries, affiliates, and distributors harmless against all claims, costs, damages, and expenses, and reasonable attorney fees arising out of, directly or indirectly, any claim of personal injury or death associated with such unintended or unauthorized use, even if such claim alleges that ON Semiconductor was negligent regarding the design or manufacture of the part. ON Semiconductor is an Equal Opportunity/Affirmative Action Employer. This literature is subject to all applicable copyright laws and is not for resale in any manner.

PUBLICATION ORDERING INFORMATION

LITERATURE FULFILLMENT:

Literature Distribution Center for ON Semiconductor
 19521 E. 32nd Pkwy, Aurora, Colorado 80011 USA
Phone: 303-675-2175 or 800-344-3860 Toll Free USA/Canada
Fax: 303-675-2176 or 800-344-3867 Toll Free USA/Canada
Email: orderlit@onsemi.com

N. American Technical Support: 800-282-9855 Toll Free
 USA/Canada
Europe, Middle East and Africa Technical Support:
 Phone: 421 33 790 2910
Japan Customer Focus Center
 Phone: 81-3-5817-1050

ON Semiconductor Website: www.onsemi.com

Order Literature: <http://www.onsemi.com/orderlit>

For additional information, please contact your local Sales Representative

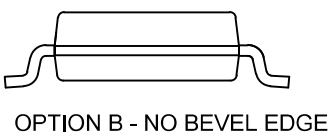
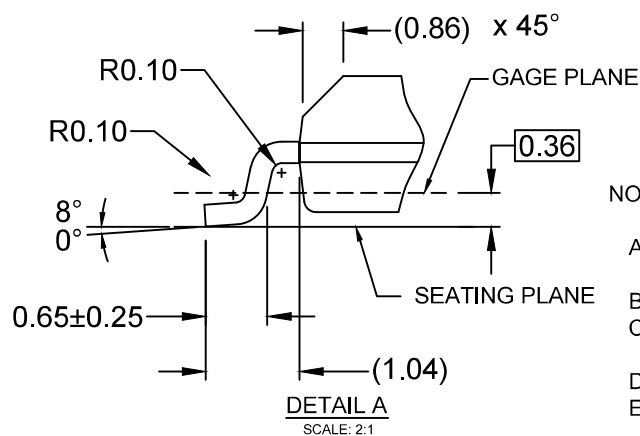
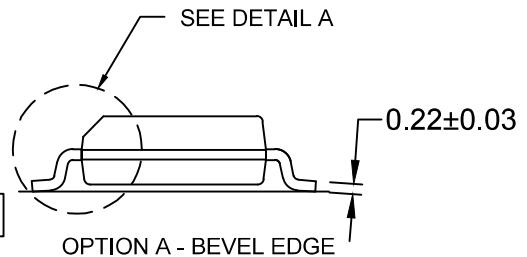
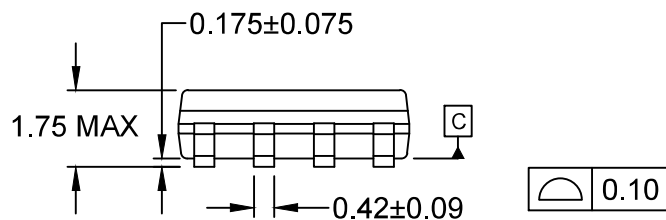
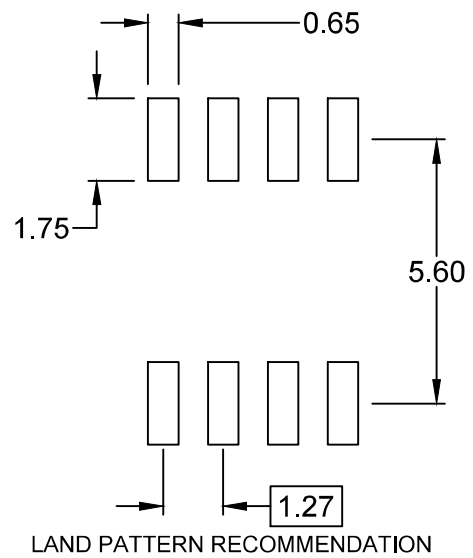
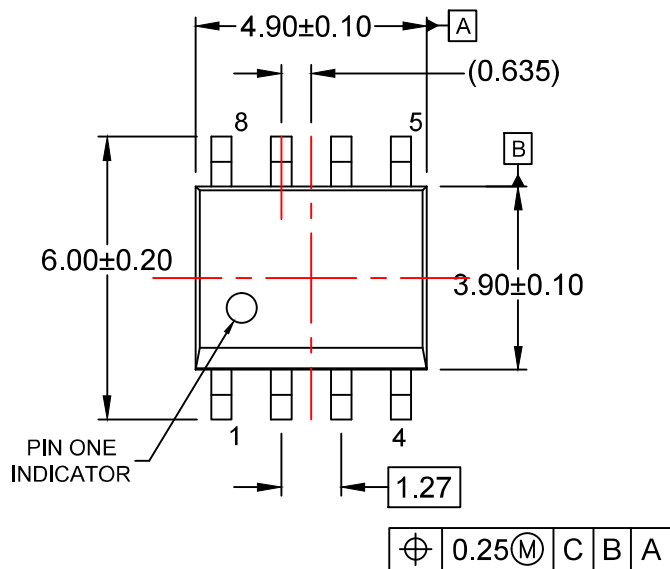

NOTES:

- A) THIS PACKAGE CONFORMS TO JEDEC MS-012, VARIATION AA.
- B) ALL DIMENSIONS ARE IN MILLIMETERS.
- C) DIMENSIONS DO NOT INCLUDE MOLD FLASH OR BURRS.
- D) LANDPATTERN STANDARD: SOIC127P600X175-8M
- E) DRAWING FILENAME: M08Arev16



ON Semiconductor and  are trademarks of Semiconductor Components Industries, LLC dba ON Semiconductor or its subsidiaries in the United States and/or other countries. ON Semiconductor owns the rights to a number of patents, trademarks, copyrights, trade secrets, and other intellectual property. A listing of ON Semiconductor's product/patent coverage may be accessed at www.onsemi.com/site/pdf/Patent-Marking.pdf. ON Semiconductor reserves the right to make changes without further notice to any products herein. ON Semiconductor makes no warranty, representation or guarantee regarding the suitability of its products for any particular purpose, nor does ON Semiconductor assume any liability arising out of the application or use of any product or circuit, and specifically disclaims any and all liability, including without limitation special, consequential or incidental damages. Buyer is responsible for its products and applications using ON Semiconductor products, including compliance with all laws, regulations and safety requirements or standards, regardless of any support or applications information provided by ON Semiconductor. "Typical" parameters which may be provided in ON Semiconductor data sheets and/or specifications can and do vary in different applications and actual performance may vary over time. All operating parameters, including "Typicals" must be validated for each customer application by customer's technical experts. ON Semiconductor does not convey any license under its patent rights nor the rights of others. ON Semiconductor products are not designed, intended, or authorized for use as a critical component in life support systems or any FDA Class 3 medical devices or medical devices with a same or similar classification in a foreign jurisdiction or any devices intended for implantation in the human body. Should Buyer purchase or use ON Semiconductor products for any such unintended or unauthorized application, Buyer shall indemnify and hold ON Semiconductor and its officers, employees, subsidiaries, affiliates, and distributors harmless against all claims, costs, damages, and expenses, and reasonable attorney fees arising out of, directly or indirectly, any claim of personal injury or death associated with such unintended or unauthorized use, even if such claim alleges that ON Semiconductor was negligent regarding the design or manufacture of the part. ON Semiconductor is an Equal Opportunity/Affirmative Action Employer. This literature is subject to all applicable copyright laws and is not for resale in any manner.

PUBLICATION ORDERING INFORMATION

LITERATURE FULFILLMENT:

Literature Distribution Center for ON Semiconductor
19521 E. 32nd Pkwy, Aurora, Colorado 80011 USA
Phone: 303-675-2175 or 800-344-3860 Toll Free USA/Canada
Fax: 303-675-2176 or 800-344-3867 Toll Free USA/Canada
Email: orderlit@onsemi.com

N. American Technical Support: 800-282-9855 Toll Free
USA/Canada
Europe, Middle East and Africa Technical Support:
Phone: 421 33 790 2910
Japan Customer Focus Center
Phone: 81-3-5817-1050

ON Semiconductor Website: www.onsemi.com
Order Literature: <http://www.onsemi.com/orderlit>
For additional information, please contact your local
Sales Representative